

DESIGNER HARDWARE

COMPLETE
GLASS, WOODEN & KITCHEN
hardware solutions

Where strength meets style...



|| AN ISO 9001:2015 CERTIFIED COMPANY ||

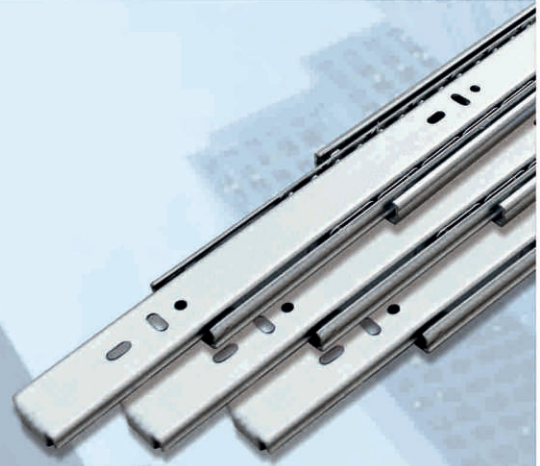

www.btxhardware.co.in

ADVANCED TECHNOLOGIES (INDIA)

COMPANY PROFILE



UNIT-1



CORPORATE OFFICE



UNIT-2

About Us : Advanced Technologies (India) is a manufacturer of architectural hardware and glass fittings Under the Brand name of BTX, which provides complete solution to residential and commercial structures. Nearly five years of a strong, customer-focused approach and continuous quest for world-class quality have enabled us to sustain leadership. Advanced Technologies (India) has an national presence with a thrust on Global Supply Chain and distribution footprint. Our products and solutions are supported by a wide network of dealers and distributors, which have helped establish a reputation for strong customer support. We believe that progress must be achieved in harmony with the socio-environment, wherein following green manufacturing practices is an integral part of its corporate vision.

Setting on a strong foundation since its inception, and guided by its customer-centric philosophy, the company leverages the power of complete architectural hardware solutions to enable infrastructure development partners to enrich with superior returns on their projects. With a mission to expand our global market outreach, Advanced Technologies strives to collaborate with its clients to provide comprehensive hardware solutions for residences and businesses.

Advanced Technologies (India) is a premier provider of an exclusive product range that includes Door Closers, Floor Springs, Glass Patch Fittings, Point Fixed Architectural Fittings, Shower Enclosure Fittings, Shower Hinges, Plastic Profiles, & Locks, Spider Fittings, Shower Sliding System, Stainless steel Railings & Balustrades, Premium range brass & Zinc handles, Cylindrical locks, Telescopic Channels, Bathroom Accessories and Aluminium Profile.

Since our inception, we function with our testing and R&D facility centre, as a result, setting industry benchmarks in hardware fittings and solutions. We are committed to partnering with its stakeholders for providing end-to-end architectural hardware products to the Architects, Builders, Fabricators, Interior Decorators, Corporate Houses, Government Contractors, and many others in the domain of residential and commercial projects. Advanced Technologies has emerged as an influential force in the continuing advancement of architectural hardware industry and has served for many popular projects, both domestic and international.

Vision: Starting as an entrepreneur we only focused on selling the best product with best prices. Our focus is always to cater to the mass market. Covering all the categories and to be the best in those. Our vision is to establish ourselves as an Industry leader in the year 2020 reaching every area in India and also to Export in other countries which involve increasing the Market Share up to 50%.

PRODUCTS INDEX

PRODUCT SERIES	PAGE NO.	PRODUCT SERIES	PAGE NO.
TELESCOPIC CHANNELS	3	DISH RACK	18
DOOR CLOSERS	4	S CORNER (L/R)	18
HYDRAULIC HINGES	5-6	MAGIC CORNER (L/R)	19
WARDROBE SLIDING TRACKS	7	PULL DOWN SYSTEM-SS	19
WOODEN DOOR SLIDING TRACKS	7	ALUMINIUM ROLLING SHUTTER	20
WARDROBE SLIDING SET	8	DOOR WASTEBIN	20
SLIDING TRACKS	8	WARDROBE LIFTUP	21
DRAWER HANDLES	8	TROUSER RACK	21
LOCKS	9	JEWELLERY BOX	22
CUTLERY TRAYS	10	RATTAN BASKET	22
TANDOM BOX DRAWER SLIDE	11	ADJUSTABLE SPINDLE FLOOR SPRING	23-24
SOFA LEGS	12	PATCH FITTINGS	25-26
GAS SPRINGS	13	NON DIGGING NEW FLOOR HINGE	27
BED LIFTERS	13	GLASS DOOR HANDLES	28-29-30
MOTORISED CLOTHES DRYING RACK	14	GLASS DOOR LOCKS	31-32
MAGNET DOOR STOPPERS	14	SLIDING DOOR ROLLERS	33
SHOE RACK	14	GLASS CLAMPS	34
KITCHEN PROFILES	14	SHOWER HINGES	35
MINI FIX	15	GLASS HEADERS	36
MULTIPURPOSE BASKET	16	BLUSTER RAILING	36
KITCHEN SKIRTING	16	GLASS SLIDING TRACKS	36
TALL UNIT	17	GLASS SEALING PROFILE	37-38
UTILITY DRAWER PULL OUT	17		

TELESCOPIC CHANNELS

BTC-501

*Soft Close Telescopic Channel
All Sizes From 16" To 24" Available
Zinc & Black Finish Available*



15 SET



BTC-502

*Push Open Telescopic Channel
All Sizes From 16" To 24" Available*

Zinc & Black Finish Available



15 SET



BTC-503

*Normal Telescopic Channel
All Sizes From 8" To 30" Available
75-78gms/finch*

Zinc & Black Finish Available



15 SET



BTC-504

*Normal Telescopic Channel
All Sizes From 10" To 20" Available
Zinc Finish Available
60-65gms/finch*



15 SET



DOOR CLOSERS

BDC-076

Capacity Upto 65kgs.
90° Auto Hold



10 PCS.



BDC-076A

Capacity Upto 65kgs.
90° Auto Hold



10 PCS.



BDC-073

Capacity Upto 80-100kgs.



10 PCS.



BDC-074

PALMET ARM DOOR CLOSER

Capacity Upto 80-100kgs.
90° Auto Hold



10 PCS.

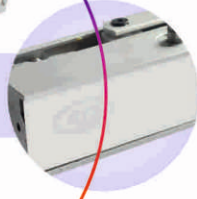

BDC-075

CONCEALED DOOR CLOSER

Capacity Upto 80-100kgs.
Min. Door Width 38mm.



10 PCS.

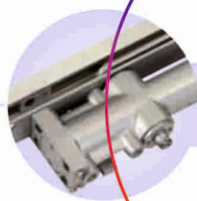

HYDRAULIC HINGES

BEC-101

Soft Close, Clip-on Hydraulic Hinge (0°, 8° & 15°)



100 SET



BEC-102

3D-Soft Close, Clip-on Hydraulic Hinge (0°, 8° & 15°)



100 SET



BEC-103

Soft Close, Clip-on Stainless Steel (SS) Hydraulic Hinge (0°, 8° & 15°)



100 SET



BEC-104

Soft Close, Wing Type Clip-on Hydraulic Hinge (0°, 8° & 15°)

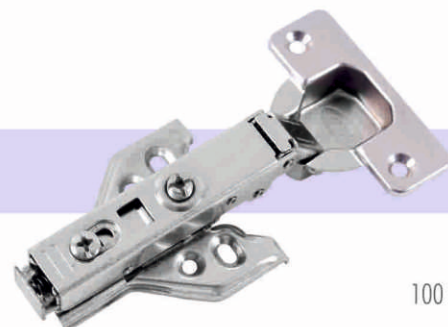

100 SET



HYDRAULIC HINGES

BEC-105

*Normal Type Hinge
(0°, 8° & 15°)*



100 SET

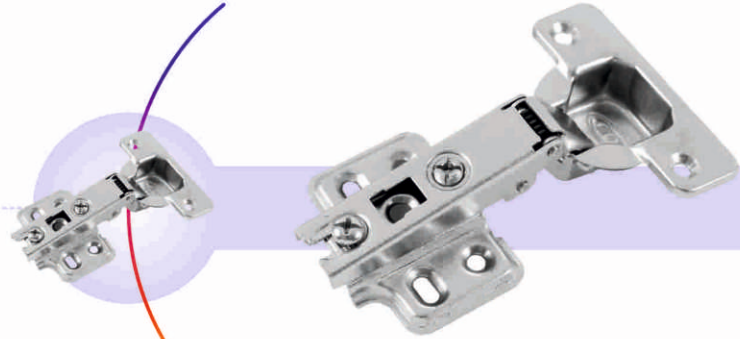

BEC-106

*Corner Hinge
Soft Close, Clip-on
Hydraulic Hinge*

100 SET

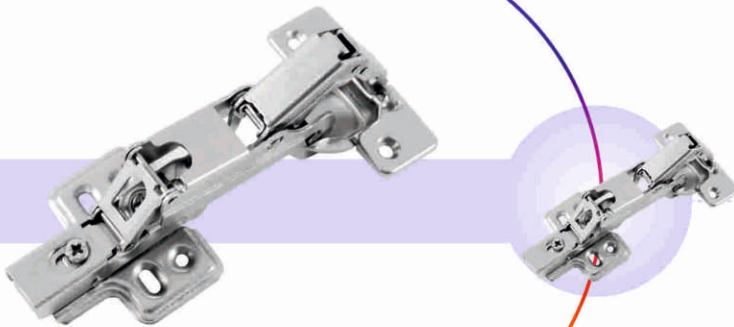

BEC-107

*Pie Hinge
Soft Close, Clip-on
Hydraulic Hinge*



100 SET

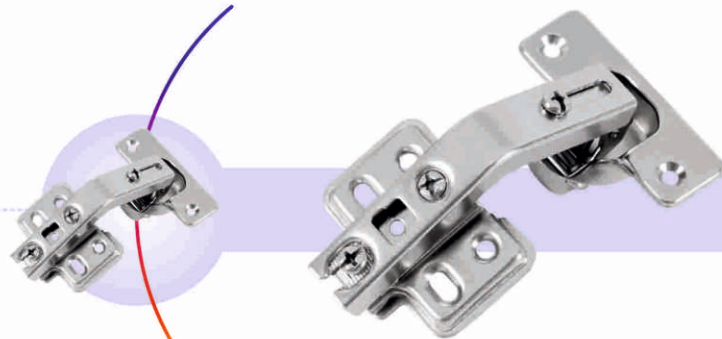

BEST QUALITY
DESIGNER HINGES



WARDROBE SLIDING TRACK

DRAWER PROFILES

BPL-101

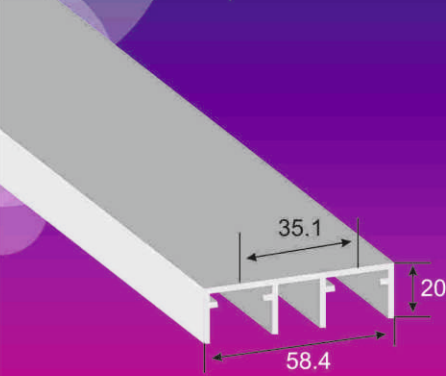

10 PCS _____ *Wardrobe sliding track*
2.4 Metre & 4 Metre



50 SET _____

BDR-101

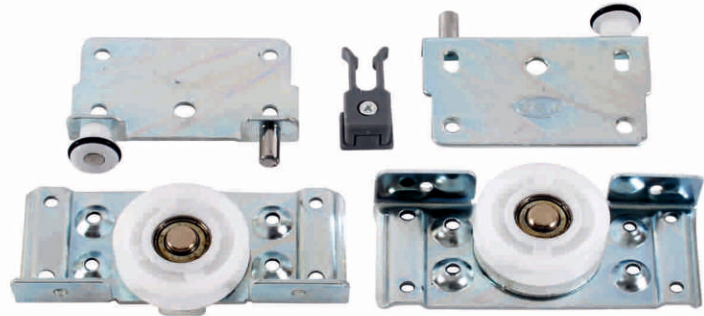

_____ *Wardrobe sliding set*

BPL-102

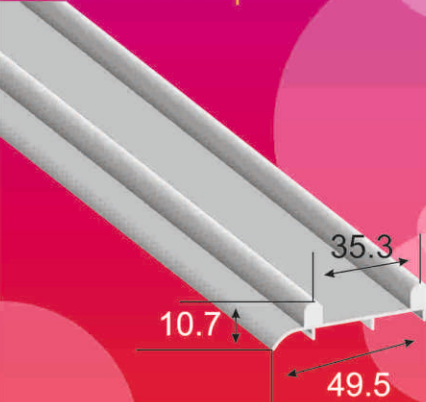

20 PCS _____ *Wardrobe sliding track*
2.4 Metre & 4 Metre



40 SET _____

BDR-102

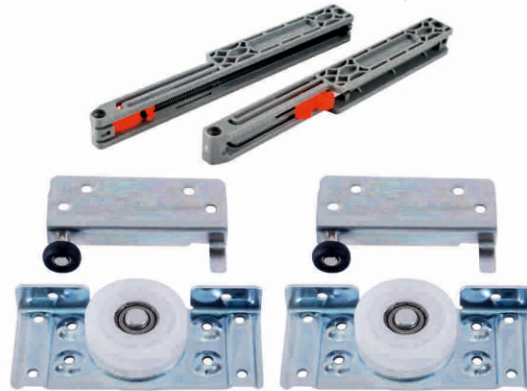

_____ *Soft close Wardrobe sliding set*

BPL-103

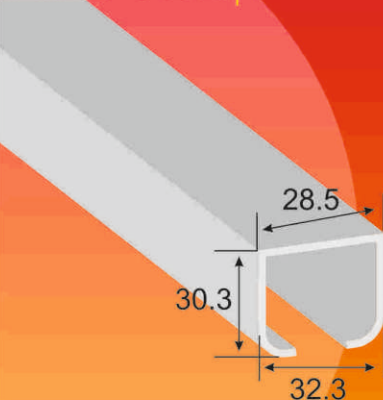

10 PCS _____ *Wooden door sliding track*
3 Metre & 4 Metre



40 SET _____

_____ *4 Wheel wooden door sliding set*

BDR-104

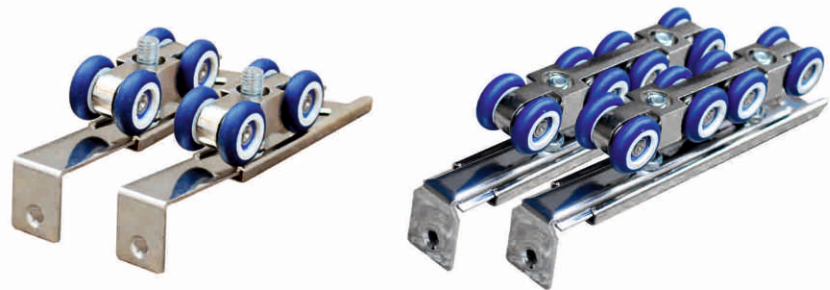

40 SET _____

_____ *8 Wheel wooden door sliding set*

DRAWER PROFILES

WARDROBE SLIDING SET

BDR-105

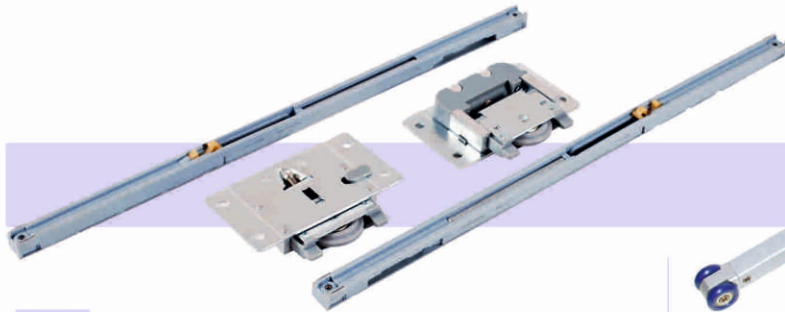

15 SET

*Wardrobe soft close slide set
Long Damper 4 Pcs + 8 Pcs Roller*

BDR-106

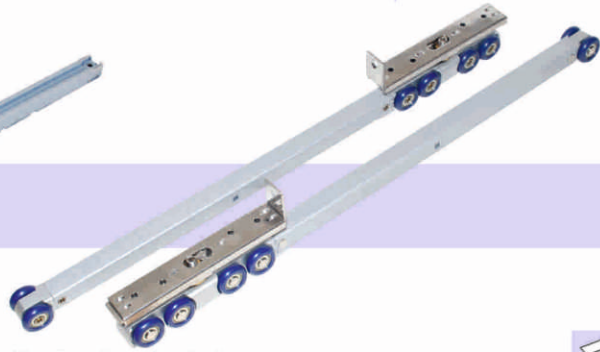

10 SET

*Wooden door 8 wheel
soft close sliding set*

BPL-104



10 SET

2.4M & 4M

PROFILES



BPL-105

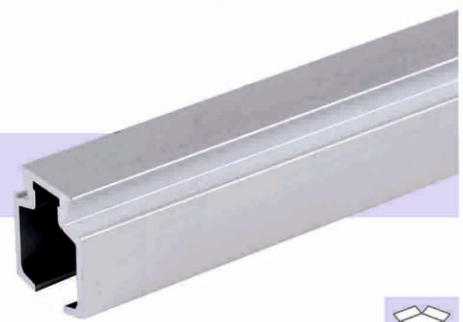

10 SET

2.4M & 4M

DRAWER HANDLES

product code
BPL-201(S)400
SILVER

product code
BPL-201(S)500
SILVER

product code
BPL-201(C)400
CHAMPAGNE

product code
BPL-201(C)500
CHAMPAGNE



Available in silver & champagne



10 PCS



10 PCS

designer hardware...

BTX[®]

H A R D W A R E

designer hardware...

LOCKS

product code BDL-201

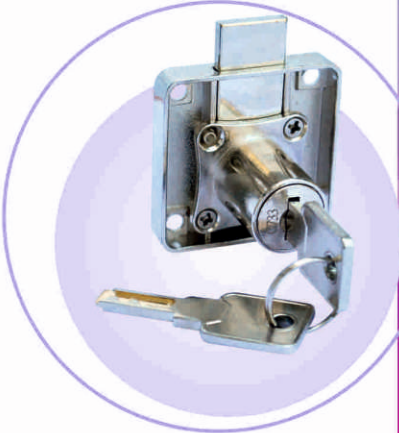

12Pcs. X 20Box = 240Pcs.

product code
BFL-001

30 PCS.

product code BDL-202

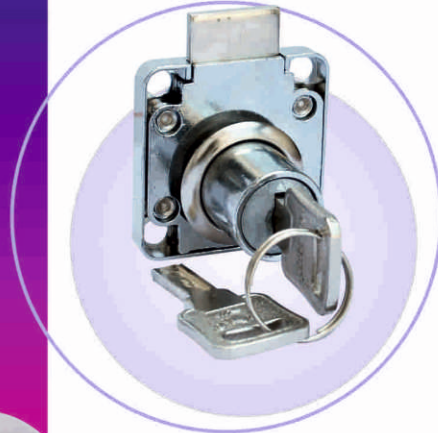

12Pcs. X 20Box = 240Pcs.



*Bathroom door bulblock
copper core & copper key
One side key one side knob
201 SS body cover
Silver & Antique Finish*

product code
BLL-001
Night latch lock

product code BDL-203



12Pcs. X 20Box = 240Pcs.

product code BDL-204



12Pcs. X 20Box = 240Pcs.



16 PCS.

LOCKS

CUTLERY TRAYS

product code
BCT-101

Cutlery tray
Cabinet Width 600mm.

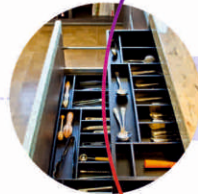

product code
BCT-104

Cutlery tray
Cabinet Width 700mm

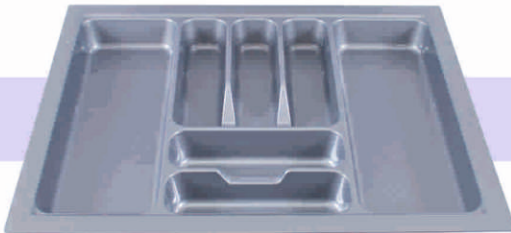

product code
BCT-102

Cutlery tray
Cabinet Width 800mm



product code
BCT-103

Cutlery tray
Cabinet Width 900mm



BTX®

H A R D W A R E

designer hardware...

TANDOM BOX DRAWER SLIDE

BTB-401 | BTB-402
4" | 6"
BTB-403
8"

Size 20"
Sleak tandem box



6 SET

BTB-501 | BTB-502
4" | 6"
BTB-503
8"

SQUARE GALLERY TANDOM BOX
Size : 20"
Square gallery tandem box.



6 SET

BTB-301 | BTB-302
4" | 6"
BTB-303
8"

Round Gallery Tandom box



10 SET

BSU-101 | BSU-102,
18" | 20"
BSU-103, BSU-104, BSU-105
12" | 14" | 16"

Under Mount Soft Close Sliders



6 SET

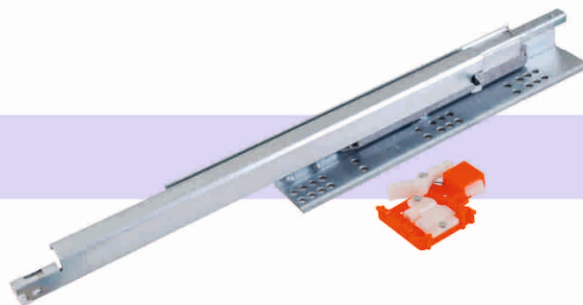
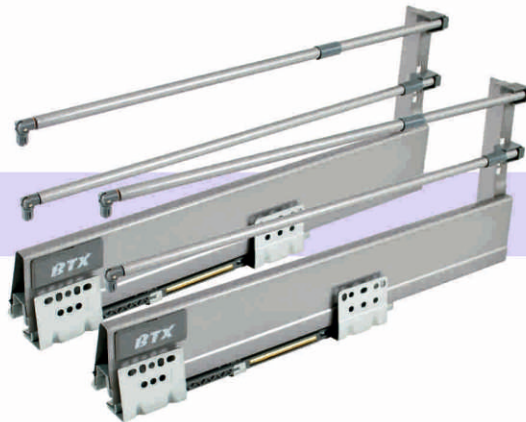
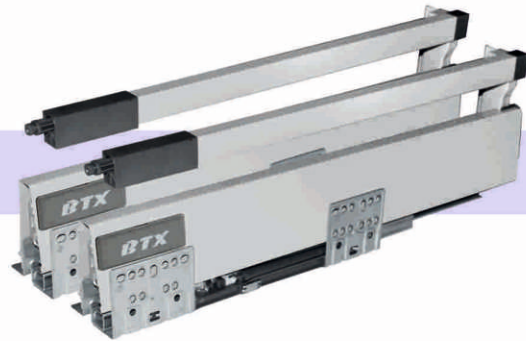

TANDOM BOX DRAWER SLIDES

WWW.BTXHARDWARE.CO.IN

SOFA LEGS



BSL-101

*One Pc. Alloy Steel Sofa Leg
Height: 8cm.*



BSL-102

*One Pc. Alloy Steel Sofa Leg
Height: 4.5cm.*



BSL-103

*Colour: Gold
Aluminium Magnesium Alloy
Height: 8cm
Height adjustable upto 1"*



BSL-104

*Colour: Red Bronze
Aluminium Magnesium Alloy
Height: 8cm
Height adjustable upto 1"*



BSL-105

*Colour: Silver Sand
Aluminium Magnesium Alloy
Height: 8cm
Height adjustable upto 1"*



BSL-106

*Colour: Silver Sand
Aluminium Magnesium Alloy
Height: 8cm
Height adjustable upto 1"*



BSL-107

*Colour: Red Bronze
Aluminium Magnesium Alloy
Height: 8cm
Height adjustable upto 1"*



BSL-108

*Colour: Silver Sand
Aluminium Magnesium Alloy
Height: 8cm
Height adjustable upto 1"*



BSL-109

*Colour: Silver Sand
Aluminium Magnesium Alloy
Height: 8cm
Height adjustable upto 1"*



BSL-110

*Colour: Red Bronze
Aluminium Magnesium Alloy
Height: 8cm
Height adjustable upto 1"*



BSL-111

*Colour: Silver Sand
Height: 7cm.*



BSL-112

*Colour: Mirror Finish
Height: 7cm.*

GAS SPRINGS

BGS-161

Soft close gas spring
50 N, 100 N, 150 N



100 PCS



BGS-301 50N
BGS-302 100N
BGS-303 150N
BGS-304 200N

Gas spring



100 PCS



BGS-613

Clip on gas spring
50N, 100N, 150N



100 PCS



BBL-001

Height : 5'
Bed lifter heavy bed holder
330mm thickness 3.5mm
1000N, 1200N, 1500N
2000N, 2500N



5 SET



MOTORISED CLOTHES DRYING RACK

BCD-201

*Golden finish
Weight capacity
Upto 35kgs.*

BCD-201

*Silver finish
Weight capacity
Upto 35kgs.*

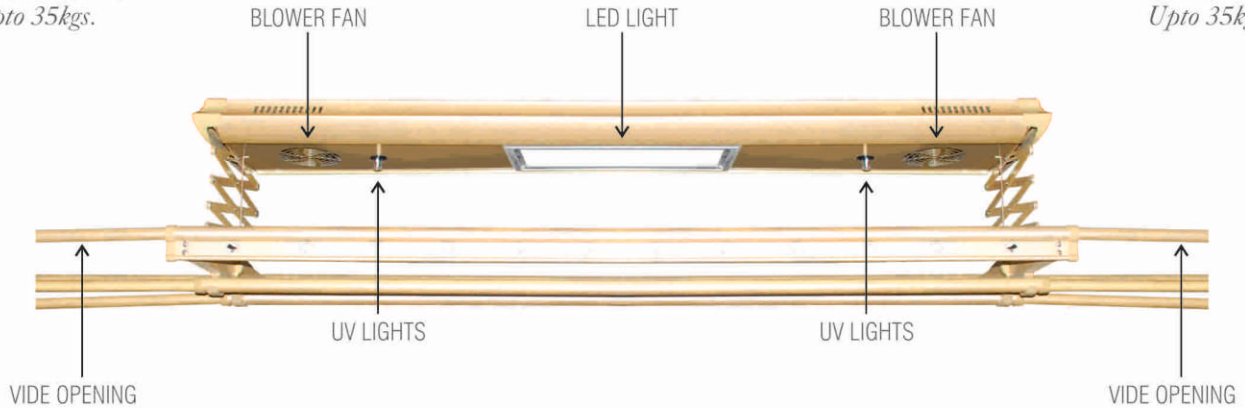

MAGNET DOOR STOPPERS

product code
BDS-001



BELL TYPE



4X50=200PCS



NORMAL

product code
BDS-002

Silver And Antique Finish Available

SHOE RACK



product code
BSR-601/602

BSR-601-8 layers, BSR-602-10 layers

KITCHEN PROFILES

product code
BAP-002

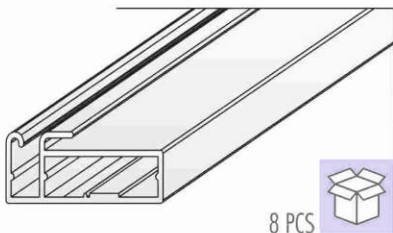

8 PCS



Handle Profile with Profile handle

product code
BAP-001

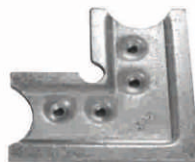

Profile Connector

product code
BAP-003

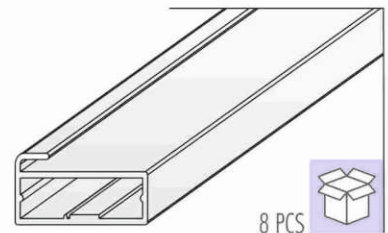

8 PCS



Frame Profile W/o. Handle

BTX[®]

H A R D W A R E

designer hardware...

MINI FIX

BMF-001



BMF-002



BMF-003



BMF-004



BMF-005



BMF-006



BMF-007

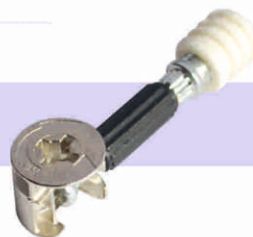

MINI FIX

WWW.BTXHARDWARE.CO.IN

BWA-007

MULTIPURPOSE BASKET

Cabinet width 900mm.
Wooden finish.

WxHxD : 450x175(200)x500mm
Finish : Beechwood
Item Code : BWA-007



BWA-008

KITCHEN SKIRTING

HxL : 100x3000mm
Finish : Grey
Item Code : BWA-008



BKA-001

- ✓ Fashion gen, with smooth close system.
- ✓ Unique anti-slip base.
- ✓ Max. 5 Kg. for big basket, 3 Kgs. for small basket.
- ✓ Height adjustable
- ✓ Material: Stainless Steel Grade 304

Cabinet Width : 450, 600mm
Finish : White



TALL UNIT

BKA-002

- ✓ Baskets can be brought out when pulling door.
- ✓ Stability in design, operations easy.
- ✓ 150mm (2 Layer)
- ✓ 200mm (2 Layer)
- ✓ 250mm (2 Layer)
- ✓ 300mm (3 Layer)
- ✓ Material: Stainless Steel SS 304

Cabinet Width : 150, 200, 250, 300mm
Finish : Grey



UTILITY DRAWER PULL OUT

BKA-003

DISH RACK

Material: Stainless Steel Grade 304

Cabinet Width : 600, 700, 800, 900, 1000mm

Finish : White

Material : Stainless Steel



BKA-004

S CORNER (L/R)

- Max. 10Kg. for easy swing tray.*
- Suitable for corner cabinets.*
- Unique anti-slip base.*
- Soft close motion.*
- Fashion generous with smooth close system*
- 2 layer-900mm flat line-white.*

Finish : White : White

Material : BKA-004-L : BKA-004-R



BKA-005

- ✓ Soft close with easy use kitchen system.
- ✓ Max. 6 Kgs. for big basket, 5Kgs. for small basket.
- ✓ Anti-slip base.
- ✓ 2 layers 900-1000mm.
- ✓ Material: Stainless Steel SS 304.

Finish : White : White
Code : BKA-005-L : BKA-005-R



MAGIC CORNER

BKA-009

- ✓ Material: Stainless Steel Grade 304

Cabinet Size : 600,-900mm
Finish : Silver SS



PULL DOWN SYSTEM-SS

BKA-007

ALUMINIUM ROLLING SHUTTER

- ✓ High quality materials, functional.
- ✓ Easy installation, beautiful appearance.
- ✓ Easy to use, Optimal Utilization.
- ✓ Material real aluminium
- ✓ Cabinet with optional width from 450, 600, 900mm

Cabinet Width : 600mm
Finish : Aluminium & Brush



BDW-001

DOOR WASTEBIN

Capacity : 14 Liters



BWA-001

- ✓ Adjustable from 830 to 1150mm.
- ✓ Grey finish.

Cabinet Size : 900mm



WARDROBE LIFTUP

BWA-002

- ✓ Soft close feature.
- ✓ Organization trouser/sarees conveniently & easy accessories.
- ✓ Cabinet width 900mm.

Cabinet Size : 900mm



TROUSER RACK

BWA-003

JEWELLERY BOX

- ✓ Cabinet width 900mm.
- ✓ Velvet finish.

Cabinet Width : 900mm



BKA-004

RATTAN BASKET

- ✓ Rattan basket with soft close system.
- ✓ Undermount slide for smooth & better movement.
- ✓ Aluminium upgrade for various sizes.
- ✓ Finish white.

Cabinet Width : 900mm



BFS-500

BFS-500 attachment
For wooden & aluminium doors.

ADJUSTABLE SPINDLE FLOOR SPRING Single Cylinder Floor Spring Machine

product size

Cement Box Size : 250x100x47mm

Cover Size : 268x123mm

Front and Back Adjust : 5mm

Material: Stainless Steel SS 304.

performance specification

Capacity : 60kg/80kg.

Door Width : 1000mm

Maximum Closing Time : 46s

Minimum Closing Time : 3s

Max Open Degree : 105°

90 HO or NHO

Two Section Speed Valve

Closing Speed : 90 - 25

Latching Speed : 25 - 0

TELESCOPIC CHANNELS



Available in Matte & Glossy Finish



FLOOR SPRING DRAWING

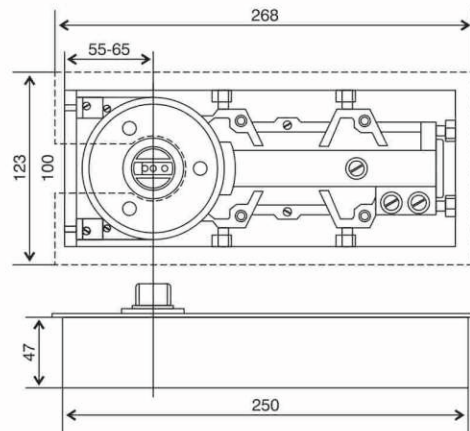
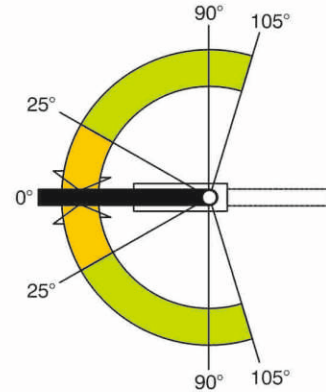

FLOOR SPRINGS

**ADJUSTABLE SPINDLE FLOOR SPRING
Double Cylinder Floor Spring Machine**

BFS-833

product size

Cement Box Size : 310x110x42mm
 Cover Size : 320x130mm
 Front and Back Adjust 5mm
 Material: Stainless Steel SS 304.

performance specification

Capacity : 130kg/100kg.
 Door Width : 1300mm/1000mm
 Maximum Closing Time 46s
 Minimum Closing Time 3s
 Max Open Degree 105° or 125°
 90 HO or NHO
 Two Section Speed Valve
 Closing Speed 90 -25
 Latching Speed 25 -0



 4 PCS.

Available in Matte & Glossy Finish

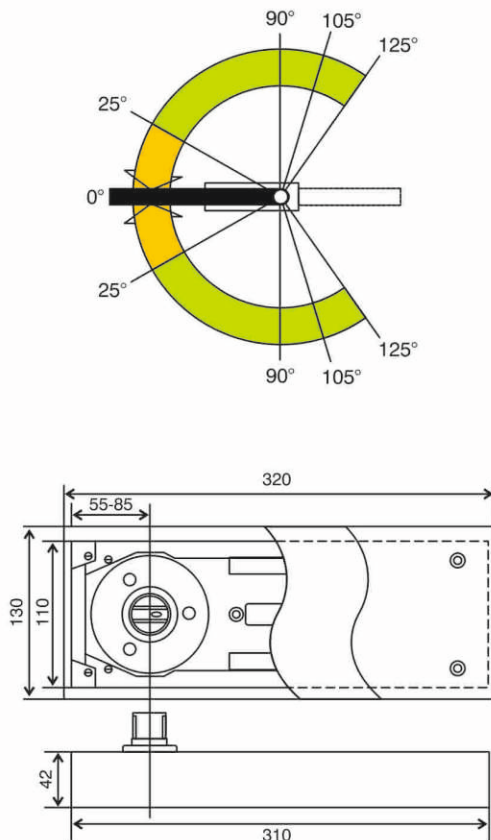

FLOOR SPRING DRAWING

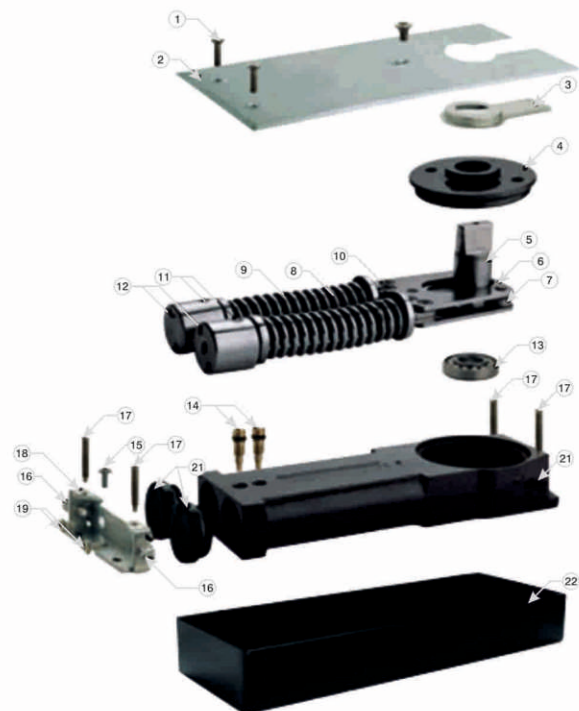

PATCH FITTINGS

BPF-01 | BOTTOM PATCH



applications

Secure On To The Bottom Of The Door Leaf To Accept The Spindle Of BTX Floor Springs.

Specifications

- ✓ With SS 304 cover of 1mm thickness.
- ✓ Ensure that the cover is secure in its place.
- ✓ It is used for 8-10mm. glasses.
- ✓ Available in glossy & mat finish.
- ✓ Material: Stainless Steel SS 304.

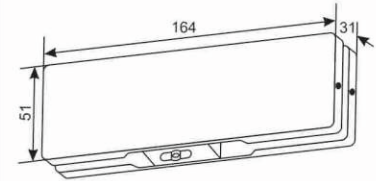

BPF-02 | TOP PATCH

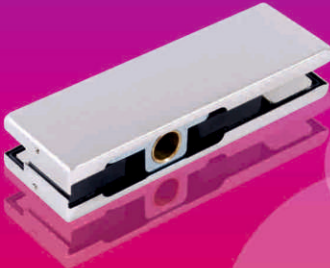

applications

Secure On To The Bottom Of The Door Leaf To Accept The Spindle Of BTX Floor Springs.

Specifications

- ✓ Variable Pivot Point Of 55 Or 65mm
- ✓ With SS 304 cover of 1mm thickness.
- ✓ Cover secured with L-Key.
- ✓ Ensure that the cover is secure in its place.
- ✓ It is used for 8-10mm. glasses.
- ✓ Available in SSS Finish.
- ✓ Material: Stainless Steel SS 304.

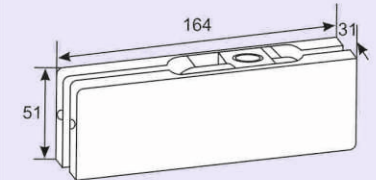

BPF-04 | L CORNER PATCH



applications

Connects Over panel and slide panel with pivot.

Specifications

- ✓ Over Panel side panel connecting panel.
- ✓ With SS 304 cover of 1mm thickness.
- ✓ Cover secured with L-Key.
- ✓ Ensure that the cover is secure in its place.
- ✓ Pivot pin of 15mm diameter.
- ✓ Adjustable pivot point /55/65mm.
- ✓ It is used for 8-10mm. glasses.
- ✓ Available in SSS Finish.
- ✓ Material: Stainless Steel SS 304.

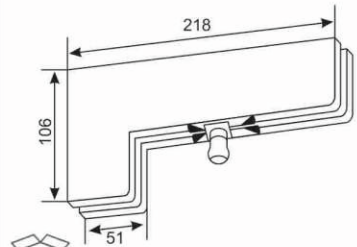

BPF-05 | LOCK PATCH



applications

To lock the double doors at bottom.

Specifications

- ✓ Centre patch lock and strike box,
- ✓ With a euro profile cylinder and strike box,
- ✓ Bolt projection of 15mm (single throw) four security keys.
- ✓ With SS 304 cover of 1mm thickness.
- ✓ Cover secured with L-Key.
- ✓ Ensure that the cover is secure in its place.
- ✓ It is used for 8-10mm. glasses.
- ✓ Available in SSS Finish.
- ✓ Material: Stainless Steel SS 304.

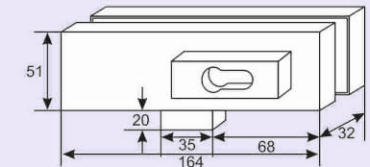

BPF-09 | SMALL L PATCH

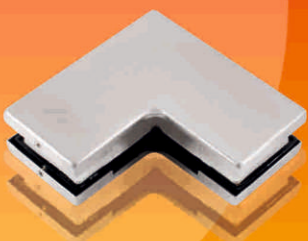

applications

Secure On To The Bottom Of The Door Leaf To Accept The Spindle Of BTX Floor Springs.

Specifications

- ✓ Over Panel side panel connecting panel.
- ✓ With SS 304 cover of 1mm thickness.
- ✓ Cover secured with L-Key.
- ✓ Ensure that the cover is secure in its place.
- ✓ It is used for 8-10mm. glasses.
- ✓ Available in SSS Finish.
- ✓ Material: Stainless Steel SS 304.

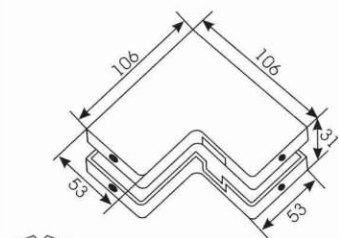

BPF-14

applications

To secure over panel with the wall with a pivot of 15mm diameter

Specifications

- / With SS 304 cover of 1mm thickness.
- / Cover secured with L-Key.
- / Ensure that the cover is secure in its place.
- / It is used for 8-10mm. glasses.
- / Available in SSS Finish.
- / Material: Stainless Steel SS 304.

TOP CORNER/OVAR PANEL PATCH

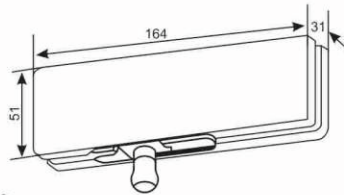

20 PCS. SET

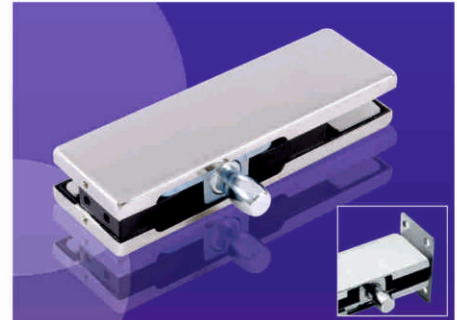

BPF-18

applications

Integrating four glasses and connecting with a fin.

Specifications

- / Quadruple connector with fin.
- / With SS 304 cover of 1mm thickness.
- / Cover secured with L-Key.
- / Ensure that the cover is secure in its place.
- / It is used for 8-10mm. glasses.
- / Available in SSS Finish.
- / Material: Stainless Steel SS 304.

TOP JUNCTION PATCH FITTING WITH FIN

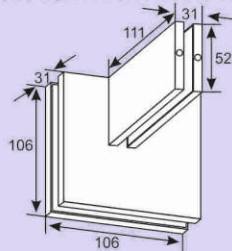

20 PCS. SET



BPF-20

applications

For integrating a maximum of four numbers of fixed glasses.

Specifications

- / Quadruple connector with fin.
- / With SS 304 cover of 1mm thickness.
- / Cover secured with L-Key.
- / Ensure that the cover is secure in its place.
- / It is used for 8-10mm. glasses.
- / Available in SSS Finish.
- / Material: Stainless Steel SS 304.

SINGLE PATCH

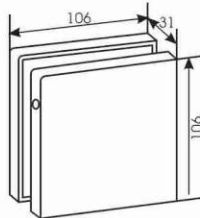

20 PCS. SET



BPF-21

applications:

For back to back doors with pivot pins. installed on to over panel.

Specifications

- / With pivot pin of 15mm diameter.
- / Connecting fin with the over panel.
- / With SS 304 cover of 1mm thickness.
- / Cover secured with L-Key.
- / Ensure that the cover is secure in its place.
- / It is used for 8-10mm. glasses.
- / Available in SSS Finish.
- / Material: Stainless Steel SS 304.

DOUBLE OBER PANEL PATCH FITTING WITH FIN

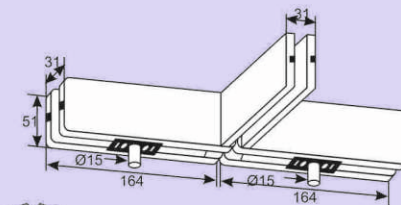

20 PCS. SET



BPF-6606

Specifications

- / Top pivot with 14.8mm
- / With resistant.
- / Suitable with top patch BPF-02
- / Finish : SSS
- / Material: Stainless Steel SS 304.

SMALL L PATCH

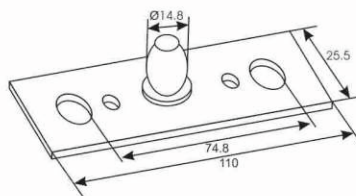

50 PCS. SET



BFS-67

Finish : Matte & Gloss

PERFORMANCE SPECIFICATION

- Max Open Degree 150°
- 90° HO or NHO
- Two section speed valve
- Closing speed 90°-10°
- Latching speed 10°-0°
- 100 Kg. weight capacity

PRODUCT SIZE

-  Glass Thickness
8mm-13mm
-  Door Width
1000mm Max
-  Capacity
100-150KG



10 PCS.

Material: Stainless Steel SS 304.

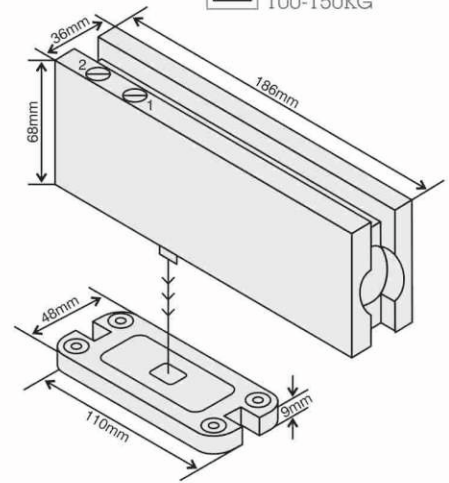

INSTALLATION INSTRUCTION

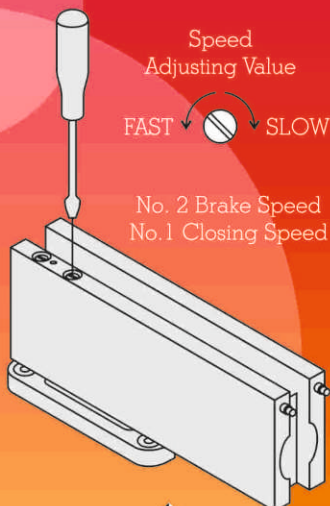
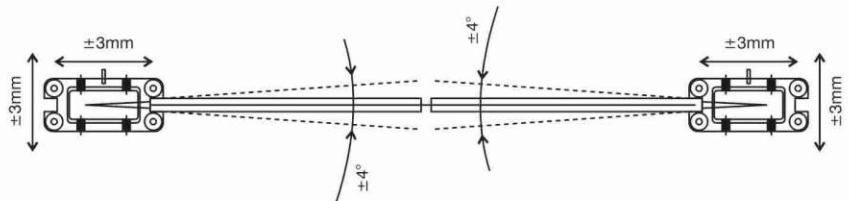

SPEED ADJUSTABLE

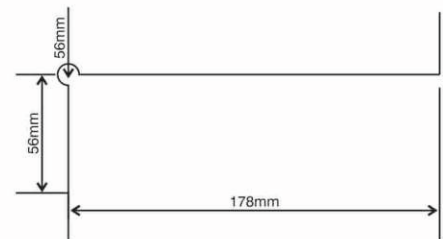
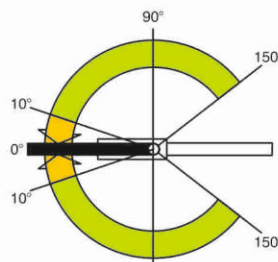

GLASS CUTTING

GLASS DOOR HANDLES

BDH-122

specification

Finish : Satin Stainless Steel (SSS)

Wood/polish Stainless Steel (TW/PSS)



*All sizes in mm



20 PCS.

Overall Length of Handle (A)	Centre to Centre Hole (B)	Diameter of Handle (C)	Hole Diameter for Glass
450	300	32	12

BDH-130

specification

Finish : Satin Stainless Steel (SSS)

Polish Stainless Steel (PSS)

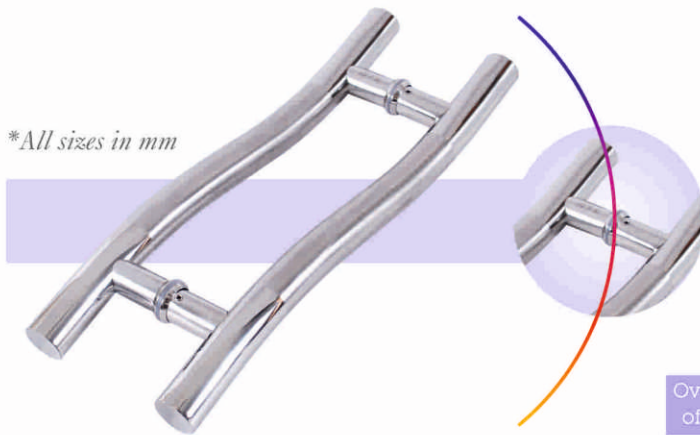

*All sizes in mm

20 PCS.

Overall Length of Handle (A)	Centre to Centre Hole (B)	Diameter of Handle (C)	Hole Diameter for Glass
450	300	32	12

BDH-214

specification

Finish : Satin Stainless Steel (SSS)

Polish Stainless Steel (PSS)



*All sizes in mm



20 PCS.

PRODUCT CODE	Overall Length of Handle (A)	Centre to Centre Hole (B)	Diameter of Handle (C)	Hole Diameter for Glass
	325	--	25	12
213	400	300	32	12
214	450	300	32	12
216	600	450	32	12
215	900	600	32	12
217	1200	900	32	12
	1500	1200	32	12

BDH-200

**All sizes in mm*



BDH-228

**All sizes in mm*



BDH-250

**All sizes in mm*
1200 (A) 900 (B)



GLASS DOOR HANDLES

specification

Finish : Satin Stainless Steel (SSS)

Polish Stainless Steel (PSS)

Material : Stainless Steel

For Back To Back Installation.

With Gasket To Prevent Glass From Damage.



20 PCS.

Overall Length of Handle (A)	Centre to Centre Hole (B)	Diameter of Handle (C)	Hole Diameter for Glass
300	300	25	12

specification

Finish : Satin Stainless Steel (SSS)

Polish Stainless Steel (PSS)

Material : Stainless Steel

For Back To Back Installation.

With Gasket To Prevent Glass From Damage.



20 PCS.

Overall Length of Handle (A)	Centre to Centre Hole (B)	Diameter of Handle (C)	Hole Diameter for Glass
450	150	19	--

specification

Finish : Satin Stainless Steel (SSS)

Polish Stainless Steel (PSS)

Material : Stainless Steel

For Back To Back Installation.

With Gasket To Prevent Glass From Damage.



20 PCS.

Overall Length of Handle (A)	Centre to Centre Hole (B)	Diameter of Handle (C)	Hole Diameter for Glass
1400	900	--	12

GLASS DOOR HANDLES

BDH-121

specification

Finish : Satin Stainless Steel (SSS)
 Wood/polish Stainless Steel (TW/PSS)
 Material : Wood/stainless Steel



20 PCS.

Overall Length of Handle (A)	Centre to Centre Hole (B)	Diameter of Handle (C)	Hole Diameter for Glass
300	300	25	12

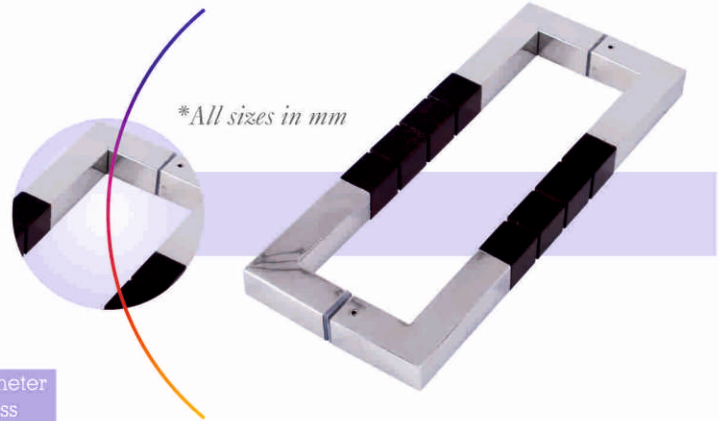

BDH-120

specification

Finish : Satin Stainless Steel (SSS)
 Polish Stainless Steel (PSS)
 Material : Stainless Steel

*All sizes in mm

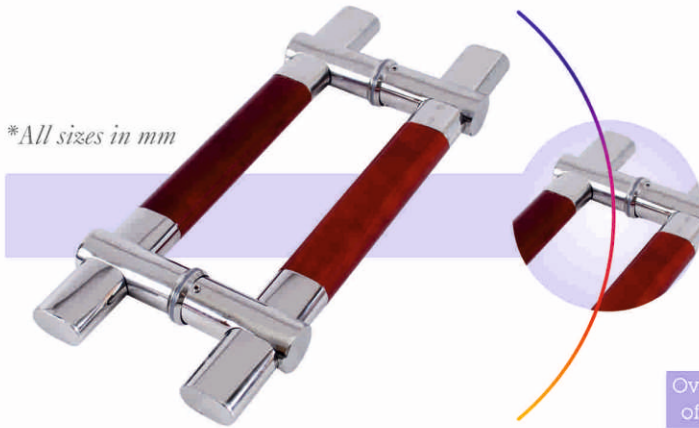

20 PCS.

Overall Length of Handle (A)	Centre to Centre Hole (B)	Diameter of Handle (C)	Hole Diameter for Glass
450	300	25/32	12

BDH-500

specification

Finish : Satin Stainless Steel (SSS)
 Polish Stainless Steel (PSS)
 Material : Stainless Steel



1 PCS.

Overall Length of Handle (A)	Centre to Centre Hole (B)	Diameter of Handle (C)	Hole Diameter for Glass
600	450	32	12



BDL-128A



specification :

Finish : Stain stainless steel (SSS)
 Suitable for 10\12mm glass.
 Suitable for glass to glass
 Lock requires no cutout in glass



GLASS DOOR LOCKS

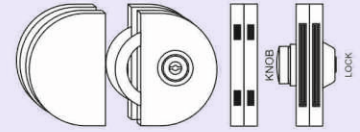

Double side door lock
 (One side key One side Knob)

BDL-128B



specification :

Finish : Stain stainless steel (SSS)
 Suitable for 10\12mm glass.
 Suitable for glass wall/fix structure
 Lock requires no cutout in glass

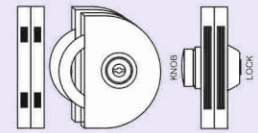

Single side door lock
 (One side key One side Knob)

BDL-118A



specification :

Finish : Stain stainless steel (SSS)
 Suitable for 10\12mm glass.
 Suitable for glass to glass
 Lock requires no cutout in glass



Double side door lock
 (One side key only)

BDL-118B



specification :

Finish : Stain stainless steel (SSS)
 Suitable for 10\12mm glass.
 Suitable for glass wall/fix structure
 Lock requires no cutout in glass

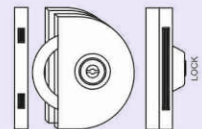

Single side door lock
 (One side key only)

BDL-138B



specification :

Finish : Stain stainless steel (SSS)
 Suitable for 10\12mm glass.
 Suitable for glass to glass
 Lock requires no cutout in glass



Double side door lock
 (Boath side Key)

GLASS DOOR LOCKS

BDL-126A

specification :

*Finish : Stain stainless steel (SSS)
Suitable for 10\12mm glass.
Suitable for glass to glass
Lock requires no cutout in glass*

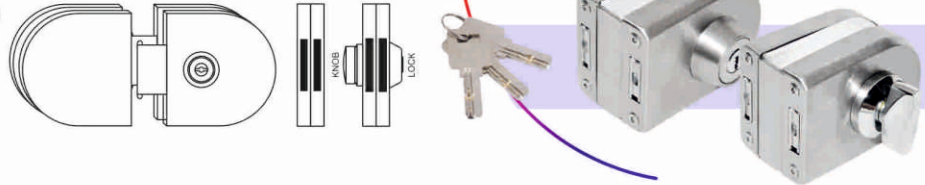

 20 PCS. SET

BDL-126B

specification :

*Finish : Stain stainless steel (SSS)
Suitable for 10\12mm glass.
Suitable for glass wallfix structure
Lock requires no cutout in glass*

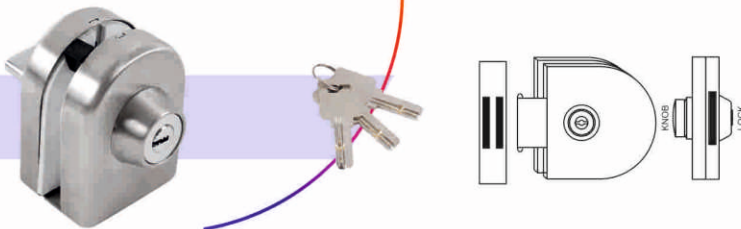

30 PCS. SET 

BDL-116A

specification :

*Finish : Stain stainless steel (SSS)
Suitable for 10\12mm glass.
Suitable for glass to glass
Lock requires no cutout in glass*



 20 PCS. SET

BDL-116B

specification :

*Finish : Stain stainless steel (SSS)
Suitable for 10\12mm glass.
Suitable for glass wallfix structure
Lock requires no cutout in glass*

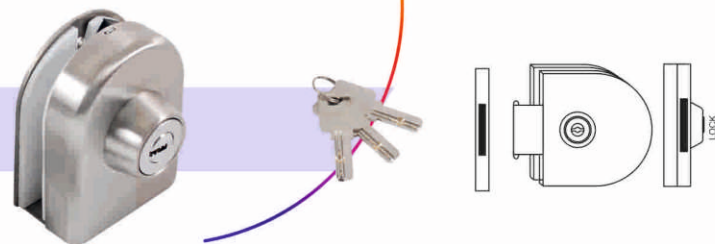

30 PCS. SET 

BDL-136A

specification :

*Finish : Stain stainless steel (SSS)
Suitable for 10\12mm glass.
Suitable for glass to glass
Lock requires no cutout in glass*

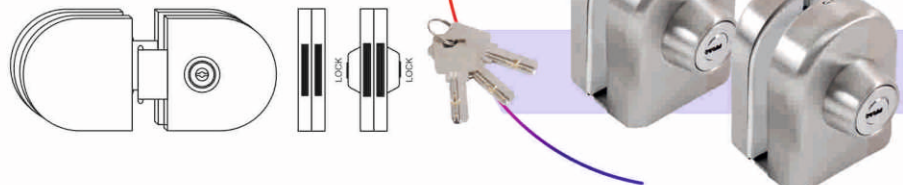

 20 PCS. SET

BDF-5005

Specifications:
 Roller for glass door.
 Heavy duty sliding door roller
 Suitable for 60Kg. door weight per pair.
 Metal body with PVC wheel
 Material used: Stainless Steel
 Finish: SSS

SLIDING DOOR ROLLER



SLIDING DOOR ROLLER

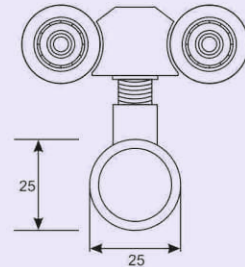

BDF-5007

Specifications:
 Roller assembly.
 Heavy duty sliding door roller
 Suitable for 80Kg. door weight per pair.
 Suitable for 10mm to 12mm glass.
 Metal body with PVC wheel
 Material used: Stainless Steel
 Finish: SSS

SLIDING DOOR ROLLER

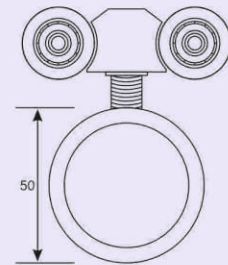

BDF-5002

Specifications:
 Heavy duty sliding door roller
 Suitable for 100Kg. door weight per pair.
 Suitable for 10mm to 12mm glass.
 Metal body with PVC wheel
 Material used: Stainless Steel
 Finish: SSS

SLIDING DOOR ROLLER

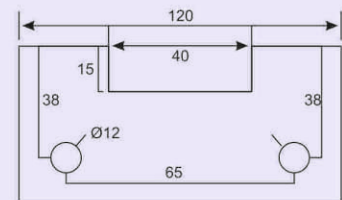
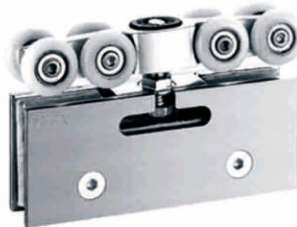

BSG-A01-7

Specifications:
 Good smooth finish.
 Glass hole dia 50mm.
 Material used: Stainless Steel
 Finish: SSS

SLIDING DOOR HANDLE

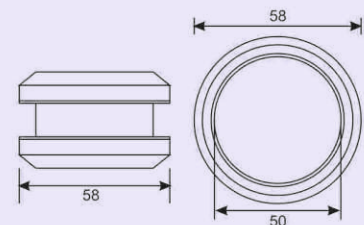

SLIDING SETS



BSG-A01-1(M)

Shower Sliding Set



BDF-5008(S)

Office Sliding Set

GLASS CLAMPS

BGC-511(S)



*0 Fixed
Glass Clamp*

BGC-511(M)

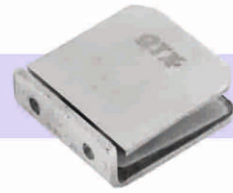

*0 Fixed
Glass Clamp*

BGC-512(S)



*90 Single
Fixed Glass Clamp*

BGC-512(M)



*90 Single
Fixed Glass Clamp*

BGC-513(S)



*90 Double
Fixed Glass Clamp*

BGC-513(M)



*90 Double
Fixed Glass Clamp*

BGC-517(S)



*180 Double
Fixed Glass Clamp*

BGC-517(M)



*180 Double
Fixed Glass Clamp*

BSH-522



specification :
 Wall to glass hinge
 Material : (M)-1SS304 (Z)-Zinc

SHOWER HINGES

90° DOUBLE SIDE SHOWER HINGE

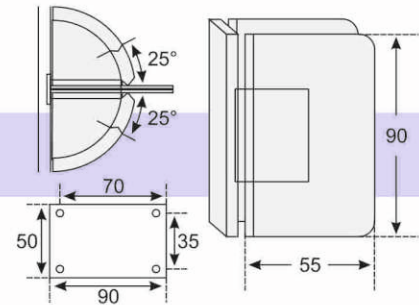

BSH-524



specification :
 Glass to glass hinge 135
 Material : (M)-1SS304 (Z)-Zinc

135° SHOWER HINGE

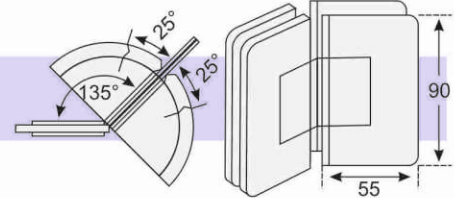

BSH-525



specification :
 Glass to glass hinge 180
 Material : (M)-1SS304 (Z)-Zinc

180° SHOWER HINGE

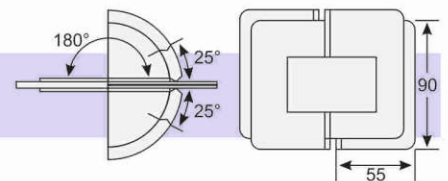

BSH-526



specification :
 Glass to glass hinge 90
 Material : (M)-1SS304 (Z)-Zinc

90° DOUBLE SIDE SHOWER HINGE

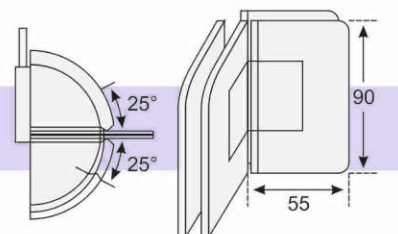

GLASS HEADERS

BDF-SB-01



Shower bracket wall clamp
Material : Brass

BDF-SB-02



Shower bracket support clamp
Material : Brass

BDF-SB-03



Shower bracket end clamp
Material : Brass

BDF-SB-04



Shower bracket clamp
(Two Way Connecting Rod)
Material : Brass

BDF-SB-05



Shower bracket clamp
(Three Way Connecting Rod)
Material : Brass

BLUSTER RAILING

BDF-BL-01



RAILING PILLER MATT FINISH
SIZE : 6" & 9"

BDF-BL-02



RAILING PILLER MATT FINISH
SIZE : 6" & 9"

BDF-BL-03



RAILING SUPPORT CLAMP

BDF-BL-04



RAILING STUD

PROFILES

BDF-9139



SLIDING TRACK
LENGTH : 10FT. & 13FT.

BDF-9138



SLIDING TRACK
LENGTH : 10FT. & 13FT.

BDF-9137



SLIDING TRACK
LENGTH : 10FT. & 13FT.

BDL-GP-01

*All sizes in mm

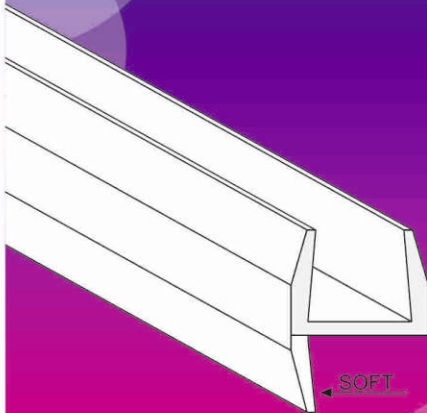

SOFT

specification

Central 180° Weather Seal
It used between fix panel &
Door Panel
Seal acts also as door stop.
Suitable product for
8, 10 and 12mm Glass.

GLASS SEALING PROFILE

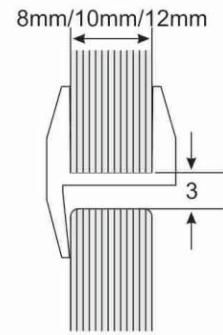

20 PCS. SET

BDL-GP-03

*All sizes in mm

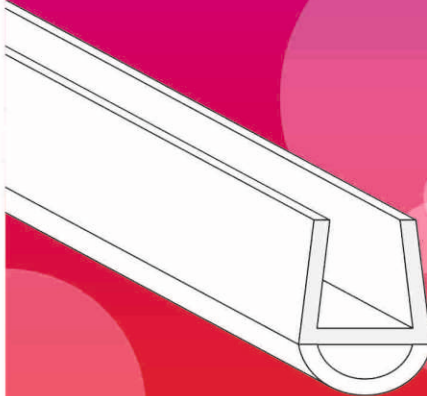

specification

Central 180° Weather Seal
Suitable product for
8, 10 and 12mm Glass.

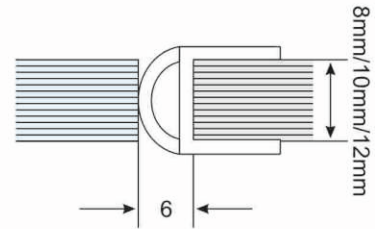

20 PCS. SET

BDL-GP-07

*All sizes in mm

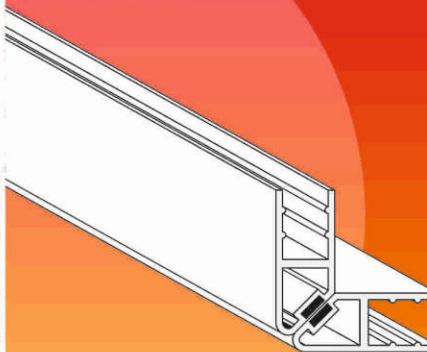

specification

Magnetic Seal for 90°
Connection transparent.
Separate product for
8, 10 and 12mm Glass.
Supplied in Paris.

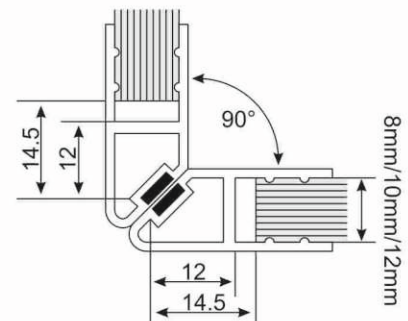

20 PCS. SET

GLASS SEALING PROFILE

BDL-GP-08

specification
 Magnetic Seal for 90°
 Connection transparent.
 Separate product for
 8, 10mm Glass.
 Supplied in Paris.

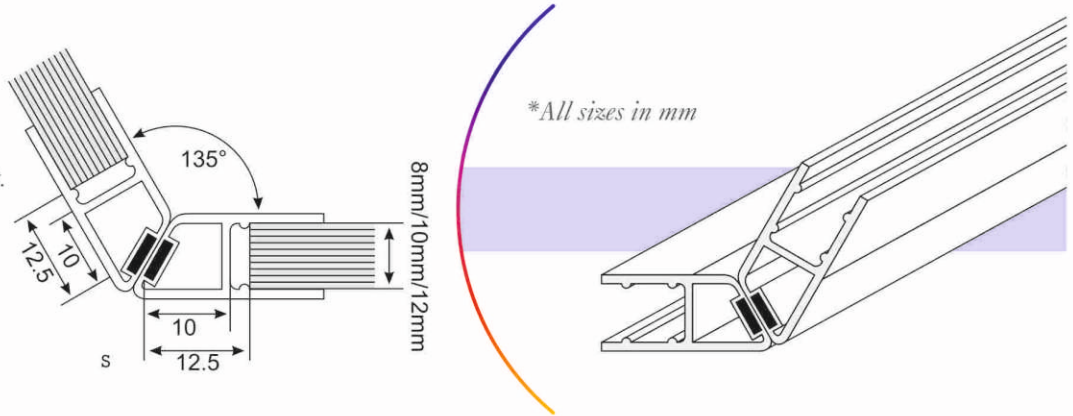

10 PCS. SET

BDL-GP-09

**All sizes in mm*

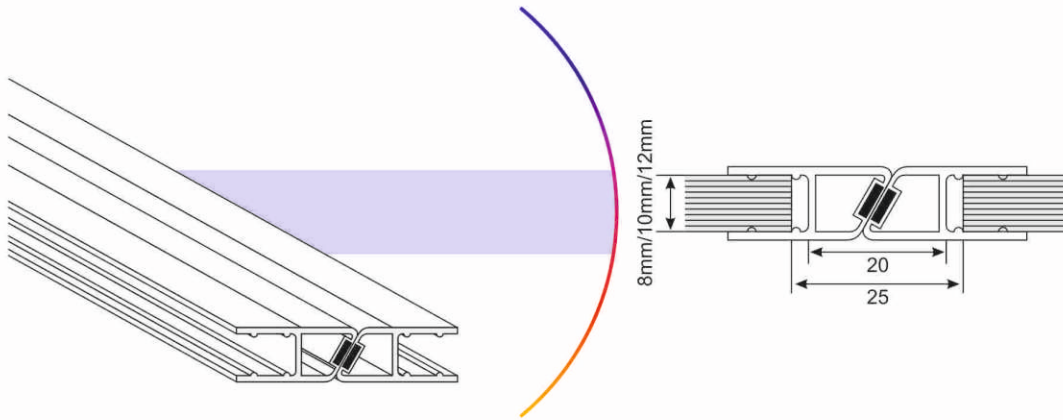

specification
 Magnetic Seal for 90°
 Connection transparent.
 Separate product
 for 8, 10mm Glass.
 Supplied in Paris.

BDL-GP-10

specification
 Sliding Seals
 For 10mm to 12mm

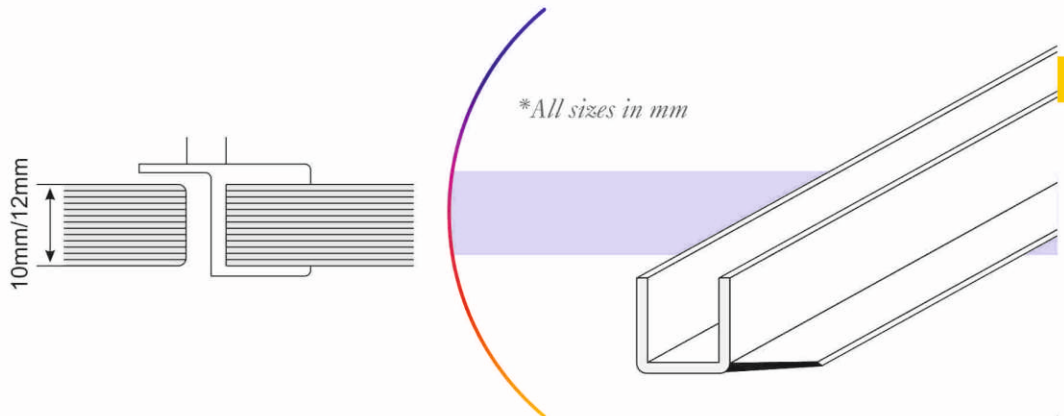

10 PCS. SET



10 PCS. SET

Where strength meets style...



|| AN ISO 9001:2015 CERTIFIED COMPANY ||

Advanced Technologies (India)



PLOT NO. C-261-B, PHASE-VIII, FOCAL POINT,
LUDHIANA. (PB.) INDIA.



+91-161-4623910
+91-94655-37267



sales@btxhardware.co.in
www.btxhardware.co.in

COMPLETE GLASS, WOODEN & KITCHEN HARDWARE SOLUTIONS

